

ISOLAMBOX

CATALOGUE ISOLAM BOX

The ISOLAMBOX catalogue contains various isothermal solutions based on the needs of transport, temperature maintenance and positioning target of the customer's product. In fact, it includes classic EPS systems to more innovative systems for optimizing space, thanks to boxes supplied flat ready for easy and quick assembly, even fully customizable.

It is possible to achieve several results combining the different solutions. Isonova will be able to take care of the development of the Packaging, guiding the customer in choosing the most suitable packaging and, upon specific request, can design a customized packaging. The amount of refrigerant required may vary depending on the environmental characteristics and content during transport.

The customer is required to carry out the appropriate tests to approve the chosen solution. Upon request as an additional service, Isonova can perform theoretical calculations to simulate the quantity of refrigerant necessary to maintain the required temperature according to the product contained and the expected external temperature.

CODES (in order):

DESCRIPTION: SC (BOX), C (PACK)

MATERIAL CODE: 326 (2mm), 464 (4mm), EPS30 (30mm), EPS38 (308mm), EPS45 (45mm), EPS50 (50mm), PP30 (30mm)

MISURES: in mm

MODEL: AM (slotted type), AU (folder type), CO (hinged flap)

ACCESSORIES:

- **THERMAL BAGS FOR ADDITIONAL INSULATION OR FOR SEPARATING THE CONTENTS FROM THE REFRIGERANT**
- **REFRIGERANTS**
- **FILM WRAP**
- **ON REQUEST DATA LOGGERS**

ALL ARTICLES IN THE CATALOGUE ARE SUPPLIED IN PACKS: 5 PCS FOR BOXES, 10 PCS FOR REFRIGERANTS AND 50 PCS FOR BAGS.

QUOTED PRICES:

Per pc/kit, IVA, transport excluded (added to invoice)

E-COMMERCE & PHARMA - TRANSPORT UP TO 48H STANDARD COURIER (FRIDGE TEMPERATURE)

FOLDING SYSTEM - CUSTOMIZABLE - HIGH QUALITY

ISOLAMBOX in LAMINIL

THESE LAMINIL BASED BOXES ARE AVAILABLE ONLY IN LAMINIL CODE 464 SILVER PET (EXTERNAL) / KRAFT PAPER (INTERNAL). THICKNESS 4mm: CODE 464
ADDITIONAL KITS FOR SLOTTED-TYPE MODELS WITH 6 WALLS OF 4CM IN EPS TO INCREASE THE DURATION OF THERMAL RESISTANCE UP TO 48H IN COMBINATION WITH SUFFICIENT QUANTITY OF REFRIGERANT.

SLOTTED-TYPE (FEFCO 0204):

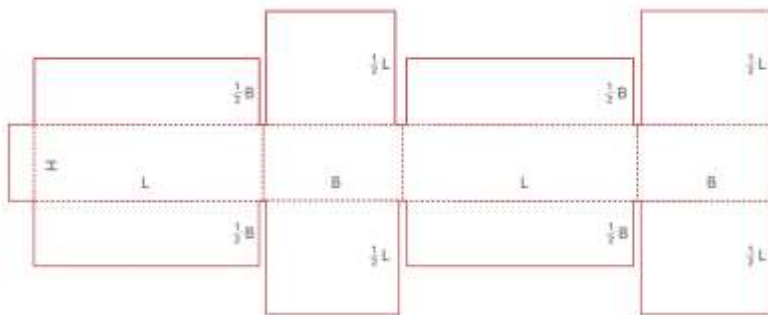

ISONOVA s.r.l.

Cap. Soc. €200.000,00 i.v. - Sede e Stabilimento: Via Brandizzo,144 - 10088 Volpiano (TO) Italy
tel +39 0119955476 - fax +39 011 9955477 - email: info@isonova.it

www.isonova.it | www.laminil.it | www.ledopack.it

C.F. / P. IVA / TVA / VAT - IT 04425740018 - R.I. Torino 2539/1983 - R.E.A. TO 632256

SCC464400300200AM

40X30X20cm (4mm)

PACK OF 5 pcs

PACK DIMENSIONS: 710x510x67mm

SCC464470260300AM

47X26X30cm (4mm)

PACK OF 5 pcs

PACK DIMENSIONS: 770X760X75mm

SCC464600400360AM

60x40x36cm (4mm)

PACK OF 5 pcs

PACK DIMENSIONS: 960x1000x60mm

SCC464450400310AM

45X40X31cm (4mm)

PACK OF 5 pcs

PACK DIMENSIONS: TBC

KIT WALLS

SCKEPS4400300200

ADDITIONAL KIT OF 6 EPS WALLS 4cm THICK FOR IMPROVED THERMAL RESISTANCE (SCA 40x30x20):

PACK OF 5 KIT

PACK DIMENSIONS: TBC

SCKEPS4470260300

ADDITIONAL KIT OF 6 EPS WALLS 4cm THICK FOR IMPROVED THERMAL RESISTANCE (SCA 47x26x30):

PACK OF 5 KIT

PACK DIMENSIONS: TBC

SCKEPS4600400360

ADDITIONAL KIT OF 6 EPS WALLS 4cm THICK FOR IMPROVED THERMAL RESISTANCE (SCA 60x40x36):

PACK OF 5 KIT

PACK DIMENSIONS: TBC

SCKEPS450400310

ADDITIONAL KIT OF 6 EPS WALLS 4cm THICK FOR IMPROVED THERMAL RESISTANCE (SCA 45X40X31):

PACK OF 5 KIT

PACK DIMENSIONS: TBC

		INTERNAL DIMENSIONS AFTER INSERTING EPS WALLS	AVAILABLE VOLUME
			L
WIDTH	470	389	15,25
LENGTH	260	179	
HEIGHT	300	219	
WIDTH	400	319	8,31
LENGTH	300	219	
HEIGHT	200	119	
WIDTH	600	519	46,19
LENGTH	400	319	
HEIGHT	360	279	
WIDTH	450	395	27,00
LENGTH	400	328	
HEIGHT	310	269	

E-COMMERCE & PHARMA – TRANSPORT UP TO 48H STANDARD COURIER (AMBIENT TEMPERATURE)

FOLDING SYSTEM – CUSTOMIZABLE – HIGH QUALITY

ISOLAMBOX in LAMINIL

THESE LAMINIL BASED BOXES ARE AVAILABLE ONLY IN LAMINIL CODE 464 SILVER PET (EXTERNAL) / KRAFT PAPER (INTERNAL). THICKNESS 4mm: CODE 464 TO BE USED IN COMBINATION WITH SUFFICIENT QUANTITY OF REFRIGERANT.

SLOTTED-TYPE (FEFCO 0204):

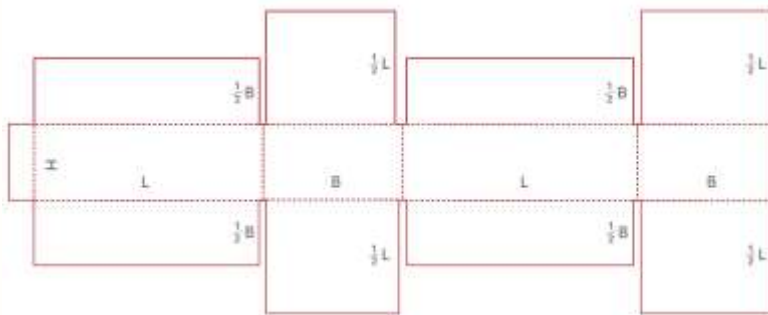

ISONOVA s.r.l.

Cap. Soc. €200.000,00 i.v. - Sede e Stabilimento: Via Brandizzo,144 - 10088 Volpiano (TO) Italy
tel +39 0119955476 - fax +39 011 9955477 - email: info@isonova.it

www.isonova.it | www.laminil.it | www.ledopack.it

C.F. / P. IVA / TVA / VAT - IT 04425740018 - R.I. Torino 2539/1983 - R.E.A. TO 632256

SCC464375225135AM

37,5X22,5X13,5cm (4mm)

PACK OF 5 pcs

PACK DIMENSIONS: 460x570x60mm

SCC464370200200AM

37x20x20cm (4mm)

PACK OF 5 pcs

PACK DIMENSIONS: 560x570x60mm

CASKET MODEL (FEFCO 0212mod):

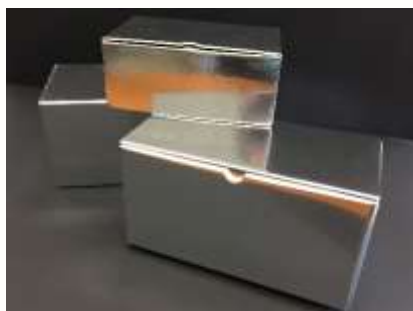
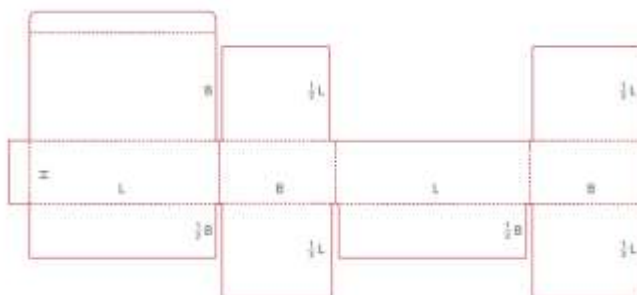

SCC464400235150CO

40x23,5x15cm (4mm)

PACK OF 5 PCS

PACK DIMENSIONS: TBC

ISONOVA s.r.l.

Cap. Soc. €200.000,00 i.v. - Sede e Stabilimento: Via Brandizzo,144 - 10088 Volpiano (TO) Italy
tel +39 0119955476 - fax +39 011 9955477 - email: info@isonova.it

www.isonova.it | www.laminil.it | www.ledopack.it

C.F. / P. IVA / TVA / VAT - IT 04425740018 - R.I. Torino 2539/1983 - R.E.A. TO 632256

TAKE AWAY - TRANSPORT UO TO 2H

FOLDING SYSTEM - CUSTOMIZABLE - HIGH QUALITY

ISOLAMBOX in LAMINIL

THESE LAMINIL BASED BOXES ARE AVAILABLE ONLY IN CODE 326 IN KRAFT PAPER FINISH. THICKNESS 2mm: CODE 326.

FOLDER-TYPE:

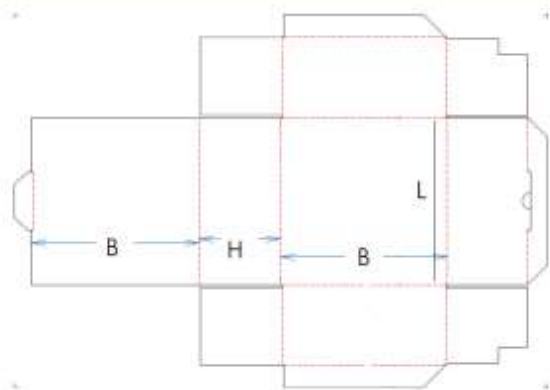

SCC32613013075AU

13x13x7,5cm (2mm)

PACK OF 5 PCS

PACK DIMENSIONS: TBC

SCC322610210105AU

21x21x10,5cm (2mm)

PACK OF 5 PCS

PACK DIMENSIONS: TBC

ISONOVA s.r.l.

Cap. Soc. €200.000,00 i.v. - Sede e Stabilimento: Via Brandizzo,144 - 10088 Volpiano (TO) Italy
tel +39 0119955476 - fax +39 011 9955477 - email: info@isonova.it

www.isonova.it | www.laminil.it | www.ledopack.it

C.F. / P. IVA / TVA / VAT - IT 04425740018 - R.I. Torino 2539/1983 - R.E.A. TO 632256

SCC326260260120AU

26x26x12cm (2mm)

PACK OF 5 PCS

PACK DIMENSIONS: 570x830x22mm

BIO ISOLAMBOX FOLDER TYPE:

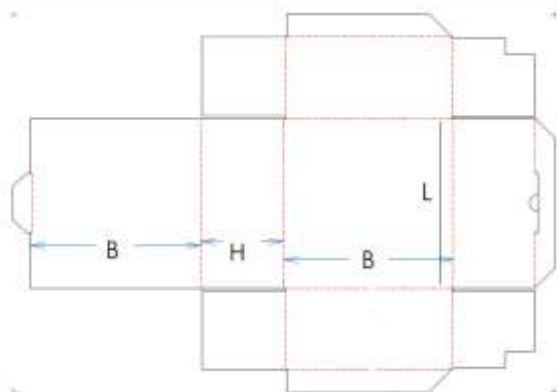

SCCBIO332220165045AU

22x16,5x4,5cm (2mm)

PACK OF 5 PCS

PACK DIMENSIONS: TBC

Laminil boxes are fully customizable, in terms of size, model, finish and print. For example:



ISONOVA s.r.l.

Cap. Soc. €200.000,00 i.v. - Sede e Stabilimento: Via Brandizzo,144 - 10088 Volpiano (TO) Italy
tel +39 0119955476 - fax +39 011 9955477 - email: info@isonova.it

www.isonova.it | www.laminil.it | www.ledopack.it

C.F. / P. IVA / TVA / VAT - IT 04425740018 - R.I. Torino 2539/1983 - R.E.A. TO 632256

E-COMMERCE & PHARMA - TRANSPORT UP TO 48H STANDARD COURIER (FRIDGE & FREEZER TEMPERATURE)

FOLDABLE SYSTEM - FAST MOUNTING

ColdFold® EPS



3kg - 1 Piece

ColdFold®

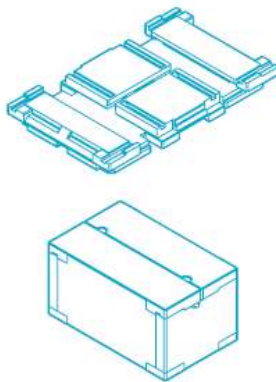

Specifications

External Length	343mm
External Width	212mm
External Height	180mm
Thickness	28mm
Internal Length	287mm
Internal Width	156mm
Internal Height	124mm

5kg - 1 Piece

ColdFold®
ColdFold XT®

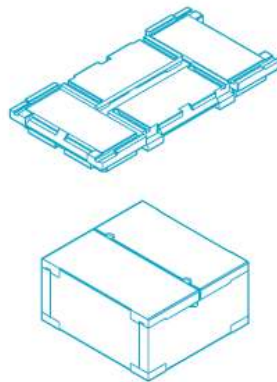

Specifications

External Length	362mm
External Width	340mm
External Height	180mm
Thickness	30mm
Internal Length	302mm
Internal Width	280mm
Internal Height	120mm

10kg - 2 Piece

ColdFold®

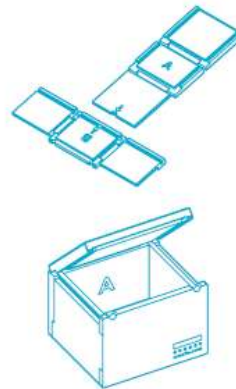

Specifications

External Length	416mm
External Width	372mm
External Height	290mm
Thickness	38mm
Internal Length	340mm
Internal Width	296mm
Internal Height	214mm

20kg - 2 Piece

ColdFold®

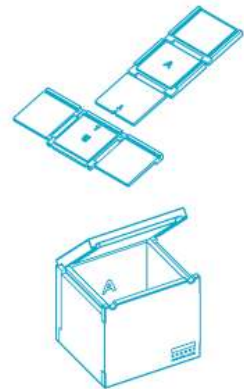

Specifications

External Length	450mm
External Width	400mm
External Height	400mm
Thickness	45mm
Internal Length	360mm
Internal Width	310mm
Internal Height	310mm

ISONOVA s.r.l.

Cap. Soc. €200.000,00 i.v. - Sede e Stabilimento: Via Brandizzo,144 - 10088 Volpiano (TO) Italy
tel +39 0119955476 - fax +39 011 9955477 - email: info@isonova.it

www.isonova.it | www.laminil.it | www.ledopack.it

C.F. / P. IVA / TVA / VAT - IT 04425740018 - R.I. Torino 2539/1983 - R.E.A. TO 632256

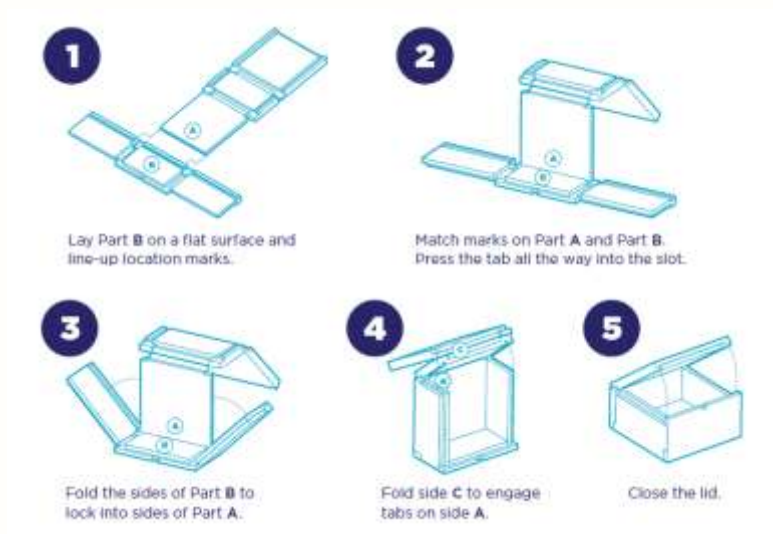

SCACFPSKG3

3Kg (2,8cm)

PACK OF 10 PCS

PACK DIMENSIONS: mm

SCACFPSKG10

10Kg (3,8cm)

PACK OF 10 PCS

PACK DIMENSIONS: mm

SCACFPSKG20

20Kg (4,5cm)

PACK OF 10 PCS

PACK DIMENSIONS: 843x603x285mm

ONLY ON REQUEST:

SCACFPSKG5

5Kg (3cm)

PACK OF 10 PCS

PACK DIMENSIONS: TBC

ONLY ON REQUEST:

ColdFold® EPS 5Kg - RE-USABLE



5kg - 1 Piece

ColdFold®
ColdFold XT®

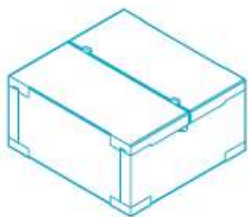
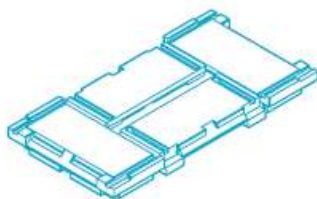

Specifications

External Length	362mm
External Width	340mm
External Height	180mm
Thickness	30mm
Internal Length	302mm
Internal Width	280mm
Internal Height	120mm

SCACFPSKG5
36,2X34X18cm (3cm)

PACK OF 10 PCS
PACK DIMENSIONS: 715x438x284mm

ISONOVA s.r.l.

Cap. Soc. €200.000,00 i.v. - Sede e Stabilimento: Via Brandizzo,144 - 10088 Volpiano (TO) Italy
tel +39 0119955476 - fax +39 011 9955477 - email: info@isonova.it

www.isonova.it | www.laminil.it | www.ledopack.it

C.F. / P. IVA / TVA / VAT - IT 04425740018 - R.I. Torino 2539/1983 - R.E.A. TO 632256

E-COMMERCE & PHARMA – TRANSPORT UP TO 48H STANDARD COURIER (FRIDGE & FREEZER TEMPERATURE)

“ECONOMY”

EPS CLASSIC (density 22 kg/m3)



SCCEPS40L16- 350350303
350 x 350 x 303 (4cm)
PALLET 24 PCS
PACK DIMENSIONS: ON PALLET

SCCEPS40L27- 595395250
595 x 395 x 250h (4cm)
PALLET DA 20 PCS
PACK DIMENSIONS: ON PALLET

SCCEPS50L42- 600400390
600 x 400 x 390 (5cm)
PALLET DA 25 PCS
PACK DIMENSIONS: ON PALLET

OTHER FORMATS ON REQUEST

ISONOVA s.r.l.

Cap. Soc. €200.000,00 i.v. - Sede e Stabilimento: Via Brandizzo,144 - 10088 Volpiano (TO) Italy
tel +39 0119955476 - fax +39 011 9955477 - email: info@isonova.it

www.isonova.it | www.laminil.it | www.ledopack.it

C.F. / P. IVA / TVA / VAT - IT 04425740018 - R.I. Torino 2539/1983 - R.E.A. TO 632256

ACCESSORIES

ISOTHERMAL BAGS

The isothermal bags can be used as primary packaging or to separate the refrigerant from the product avoiding contact.



- COD PFLABAG4727
656 DIMENSIONS 47X27cm
PACK OF 50 PCS
PACK DIMENSIONS: TBC



- COD PFLABAG3621+S7X2
794 WITH BELLOWS MEASURE 36X21 + S7X2
PACK OF 50 PCS
- COD PFLABAG4225+S8X2
795 WITH BELLOWS MEASURE 42X25 + S8X2
PACK OF 50 PCS
PACK DIMENSIONS: TBC

ISONOVA s.r.l.

Cap. Soc. €200.000,00 i.v. - Sede e Stabilimento: Via Brandizzo,144 - 10088 Volpiano (TO) Italy
tel +39 0119955476 - fax +39 011 9955477 - email: info@isonova.it

www.isonova.it | www.laminil.it | www.ledopack.it

C.F. / P. IVA / TVA / VAT - IT 04425740018 - R.I. Torino 2539/1983 - R.E.A. TO 632256

REFRIGERANTS

The refrigerants in this catalogue are suitable for maintaining the temperature from 0°C upwards. For temperatures below 0°C, alternative products are available, not in catalogue



ICECATCH GELPACK		
WEIGHT GR	DIMENSIONS (MM)	CODE
460	140X190X30	PFLAGEL460
690	140X240X40	PFLAGEL690



ICECATCH SOLID		
WEIGHT GR	DIMENSIONS (MM)	CODE
500	195X130X23	PFLASOLID500
1100	280X190X30	PFLASOLID1100

PACK DIMENSIONS 500gr (cod. 143433): 220x300x180mm.

ISONOVA s.r.l.

Cap. Soc. €200.000,00 i.v. - Sede e Stabilimento: Via Brandizzo,144 - 10088 Volpiano (TO) Italy
tel +39 0119955476 - fax +39 011 9955477 - email: info@isonova.it

www.isonova.it | www.laminil.it | www.ledopack.it

C.F. / P. IVA / TVA / VAT - IT 04425740018 - R.I. Torino 2539/1983 - R.E.A. TO 632256

WRAP FILM



- COD PFLAFILM2350190
PACK OF 1 PC
PACK DIMENSIONS:

TBC

ISONOVA s.r.l.

Cap. Soc. €200.000,00 i.v. - Sede e Stabilimento: Via Brandizzo,144 - 10088 Volpiano (TO) Italy
tel +39 0119955476 - fax +39 011 9955477 - email: info@isonova.it

www.isonova.it | www.laminil.it | www.ledopack.it

C.F. / P. IVA / TVA / VAT - IT 04425740018 - R.I. Torino 2539/1983 - R.E.A. TO 632256

TEST: TEMPERATURE CONTROL 2-8°C

ARTICLE: ISOLAMBOX SCA464600400360AM

INSULATION WALLS: SCKEPS4600400360

TIME: 48H

REFRIGERANTS: ICE CATCH SOLID (7,4KG)

CONTENT: 8L WATER

EXTERNAL TEMPERATURE: 30,5°C CONSTANT

EMPTY VOLUME WITH INTERNAL WALLS & REFRIGERANTS: 23,725L

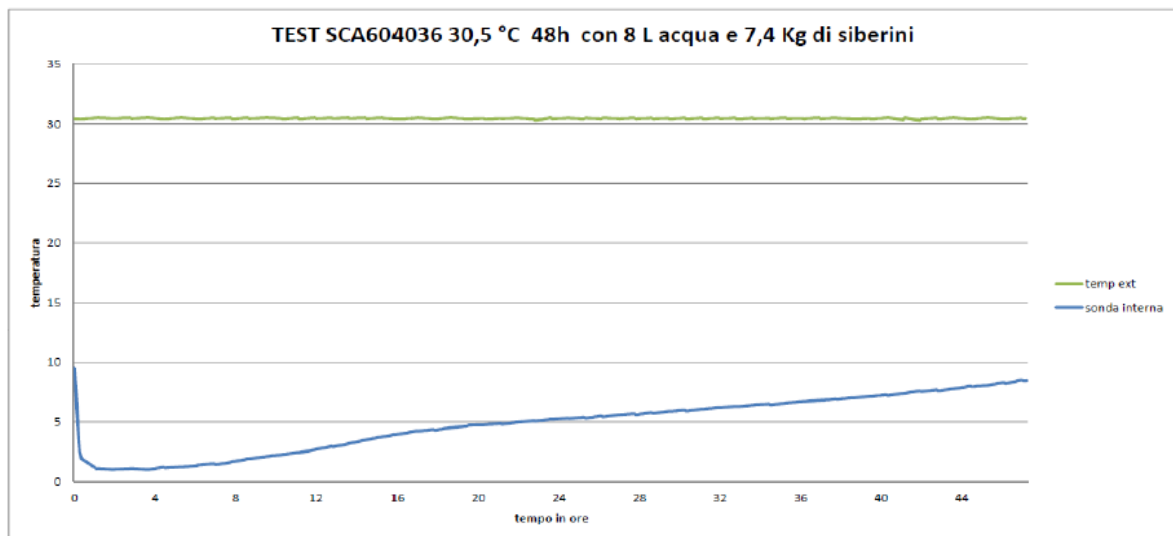

— EXT TEMPERATURE — INTERNAL LOGGER
 X TIME IN H Y TEMPERATURE



ISONOVA s.r.l.

Cap. Soc. €200.000,00 i.v. - Sede e Stabilimento: Via Brandizzo,144 - 10088 Volpiano (TO) Italy
 tel +39 0119955476 - fax +39 011 9955477 - email: info@isonova.it

www.isonova.it | www.laminil.it | www.ledopack.it

C.F. / P. IVA / TVA / VAT - IT 04425740018 - R.I. Torino 2539/1983 - R.E.A. TO 632256

TEST: TEMPERATURE CONTROL AMBIENT TEMPERATURE

ARTICLE: ISOLAMBOX SCA464400300200AM

TIME: 48H

REFRIGERANTS: ICE CATCH SOLID (1,5KG)

CONTENT: 0,5L WATER @ 18,5°C INSIDE AN ISOTHERMAL BAG PFLABAG4225+S8X2

EXTERNAL TEMPERATURE: 32°C CONSTANT

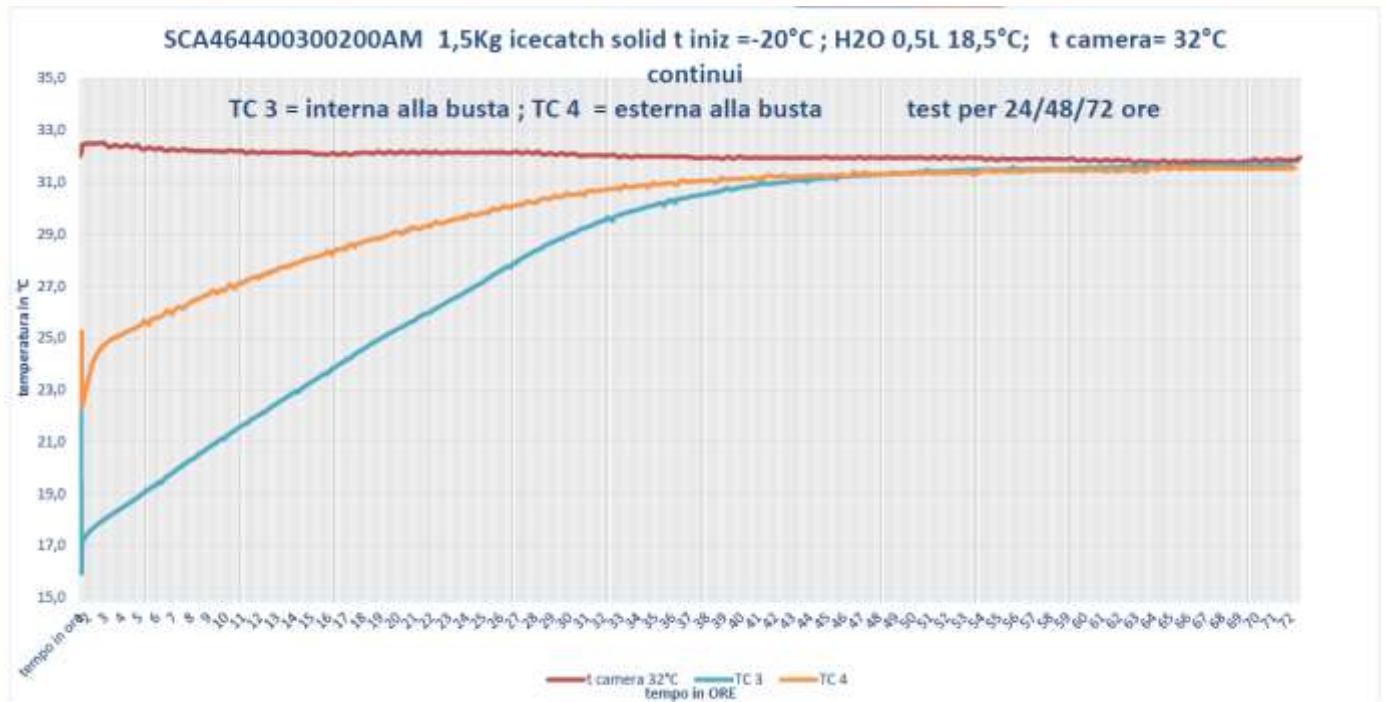

ISONOVA s.r.l.

Cap. Soc. €200.000,00 i.v. - Sede e Stabilimento: Via Brandizzo,144 - 10088 Volpiano (TO) Italy
tel +39 0119955476 - fax +39 011 9955477 - email: info@isonova.it

www.isonova.it | www.laminil.it | www.ledopack.it

C.F. / P. IVA / TVA / VAT - IT 04425740018 - R.I. Torino 2539/1983 - R.E.A. TO 632256

ColdFold®

REFRIGERANTS: ICE CATCH SOLID 7,4Kg
 CONTENT: COLD MEAT
 EXTERNAL TEMPERATURE: SUMMER
 EMPTY VOLUME WITH REFRIGERANTS: 12Kg

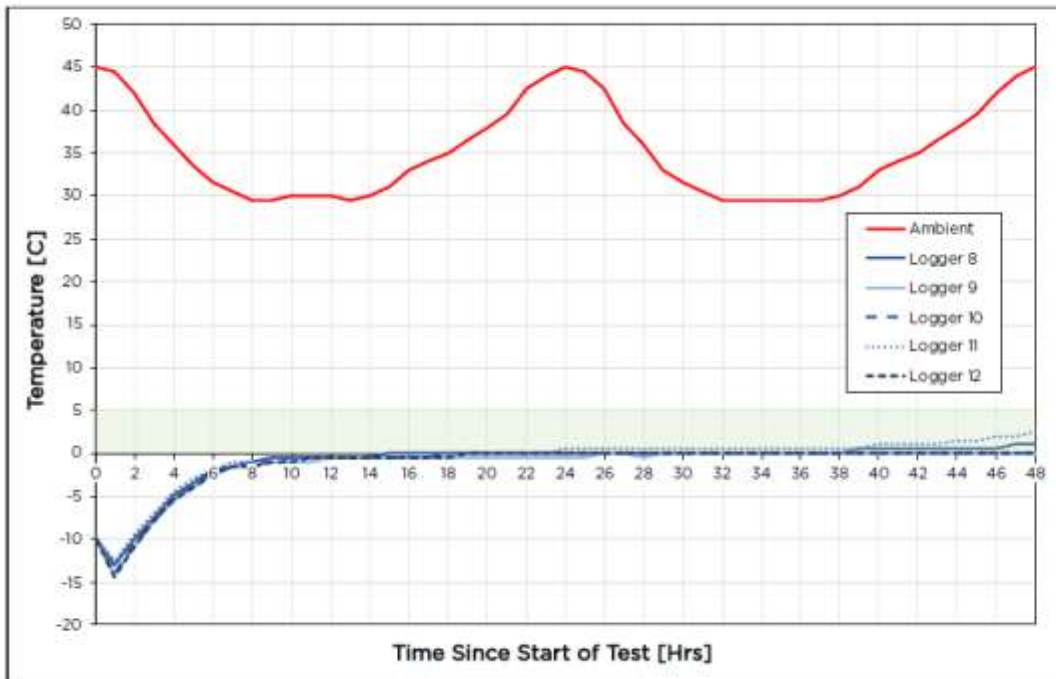

ISONOVA s.r.l.

Cap. Soc. €200.000,00 i.v. - Sede e Stabilimento: Via Brandizzo,144 - 10088 Volpiano (TO) Italy
 tel +39 0119955476 - fax +39 011 9955477 - email: info@isonova.it

www.isonova.it | www.laminil.it | www.ledopack.it

C.F. / P. IVA / TVA / VAT - IT 04425740018 - R.I. Torino 2539/1983 - R.E.A. TO 632256

ColdFold®

REFRIGERANTS: ICE CATCH SOLID 7,4Kg
 CONTENT: FROZEN PHARMACEUTICALS 6kg
 EXTERNAL TEMPERATURE: SUMMER
 EMPTY VOLUME WITH REFRIGERANTS: 12Kg

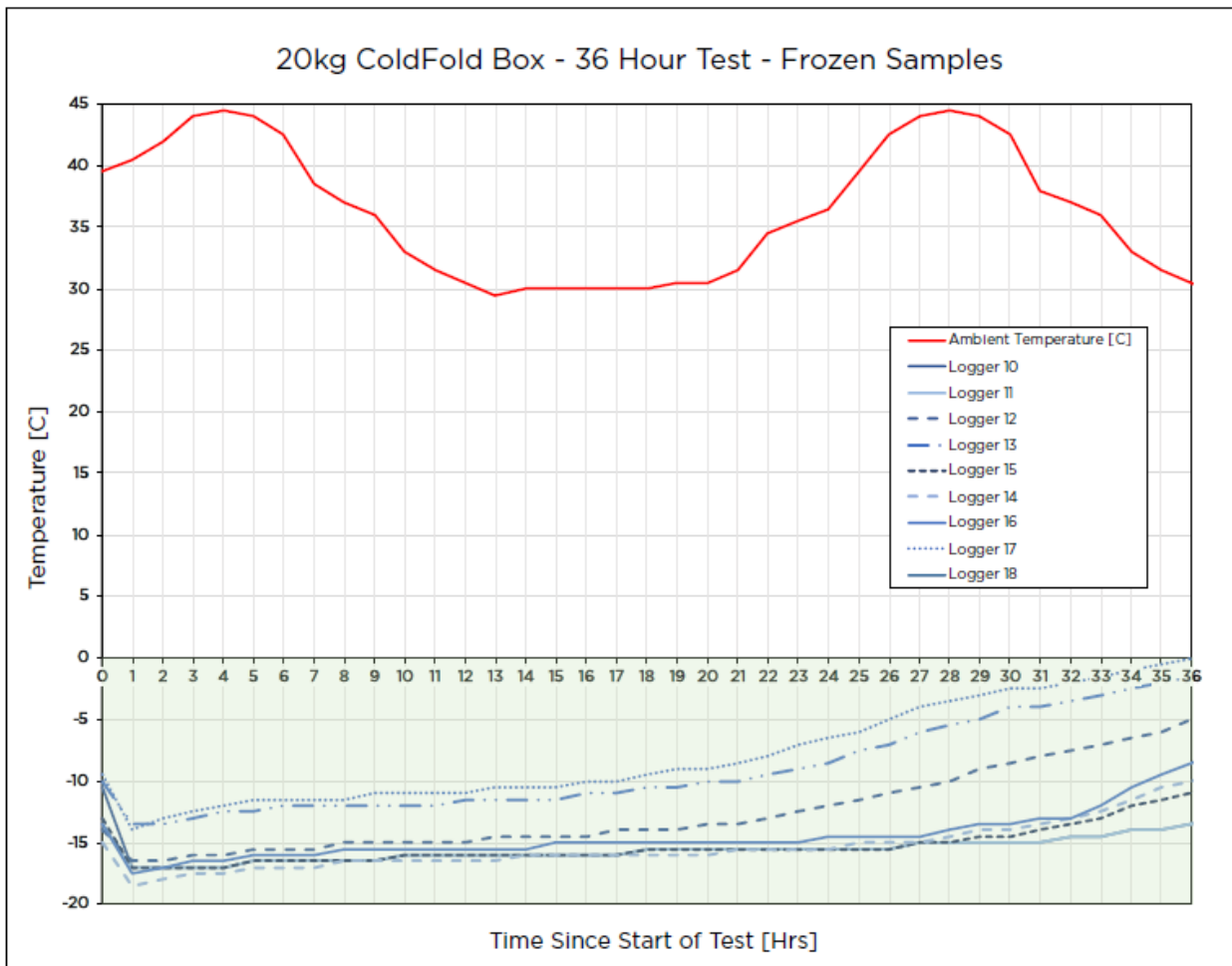

ISONOVA s.r.l.

Cap. Soc. €200.000,00 i.v. - Sede e Stabilimento: Via Brandizzo, 144 - 10088 Volpiano (TO) Italy
 tel +39 0119955476 - fax +39 011 9955477 - email: info@isonova.it

www.isonova.it | www.laminil.it | www.ledopack.it

C.F. / P. IVA / TVA / VAT - IT 04425740018 - R.I. Torino 2539/1983 - R.E.A. TO 632256